

Thank you for choosing High Lifter!

HDFFA-RZR1-1

POLARIS RZR 1000 XP - (HEAVY DUTY) FRONT FORWARD ARM KIT

Lift Kits • Tires • Suspension • Snorkels

HIGHLIFTER

Axles • Clutch Kits • Portals • Rad Kits

Contact Us

Mon-Fri 8am - 5pm CST

highlifter.com

sales@highlifter.com

800-699-0947



Read before Installation

This product is designed for use on ATVs and/or RUVs to increase ground clearance and fender clearance. Purchasers should be aware that use of this product may increase the frequency of required maintenance, part wear, and will raise the center of gravity on your ATV and/or RUV, increasing risk of roll-over, injury and death on all types of terrain. It is your responsibility to always inform other operators and passengers of this vehicle about the added risks.

High Lifter Products, products are designed to best fit users ATV/RUV under stock conditions. Adding, modifying, or fabricating any OEM or aftermarket parts will void warranty. High Lifter Products, products could interfere with other aftermarket accessories. If the user has aftermarket products on machine, contact High Lifter Products to verify that they will work together. Adding aftermarket suspension components and/or more aggressive tires can cause breakage of other OEM driveline components such as differentials, axles or drive shafts.

We recommend that wider tires and/or wheel spacers be used to achieve a wider stance and to improve stability of the ATV and/or RUV. Riders should be advised that the handling characteristics of a taller ATV and/or RUV are different and require extra care when riding, particularly on side hills or off-camber situations. If you further raise the center of gravity by adding taller tires, heavy loads to racks or seats, or by any other means, the ATV and/or RUV must be operated with even more care, at slower speeds and on relatively flat ground. All turns should be done at a slow speed, even on level ground.

Operation of an ATV and/or RUV with or without modified suspension components, while or shortly after consuming alcohol or drugs, subjects the rider to the risk of serious bodily harm or possible death. This risk is compounded if the rider does not wear an approved helmet and other safety gear. High Lifter urges that all approved safety gear be worn when riding an ATV and/or RUV as a driver or passenger.

By purchasing and installing High Lifter Products, products, user agrees that should damages occur, High Lifter Products will not be held responsible for loss of time, use, labor fees, replacement parts, or freight charges. High Lifter Products will not be held responsible for any direct, indirect, incidental, special, or consequential damages that result from any product purchased from High Lifter Products. The total liability of seller to user for all damages, losses, and causes of action, shall not exceed the total purchase price paid for the product that gives rise to the claim.

If this product is not what you expected, or is not consistent with your intended use, you should return the product immediately to the seller, before installation, for a refund of the purchase price; less any fees. After installation, product is warranted for 90 days for defects in workmanship and materials. High Lifter Products will warranty only parts provided by High Lifter Products. Any damage or problems with OEM housings, bearings, seals, or other manufacturer's products will not be covered by High Lifter Products. Parts and products will not be warranted if item was not installed properly, misused, or modified.

Dealers and other Installers

You are responsible for informing your customer and end user of the information contained above and the increased potential hazards of operating an ATV and/or RUV equipped with modified suspension components. If you install any suspension modifying components, it is your responsibility to also install the warning label prominently in view of the driver and in prominent view of the driver and passenger on RUVs and multi-passenger ATVs. They should also be instructed to notify anyone operating the vehicle, as well as any passengers, that said vehicle is modified.

As discussed above, it is critically important that they be instructed in the need for slower speed operation, regardless of terrain, after this lift kit is installed.

PARTS DIAGRAM

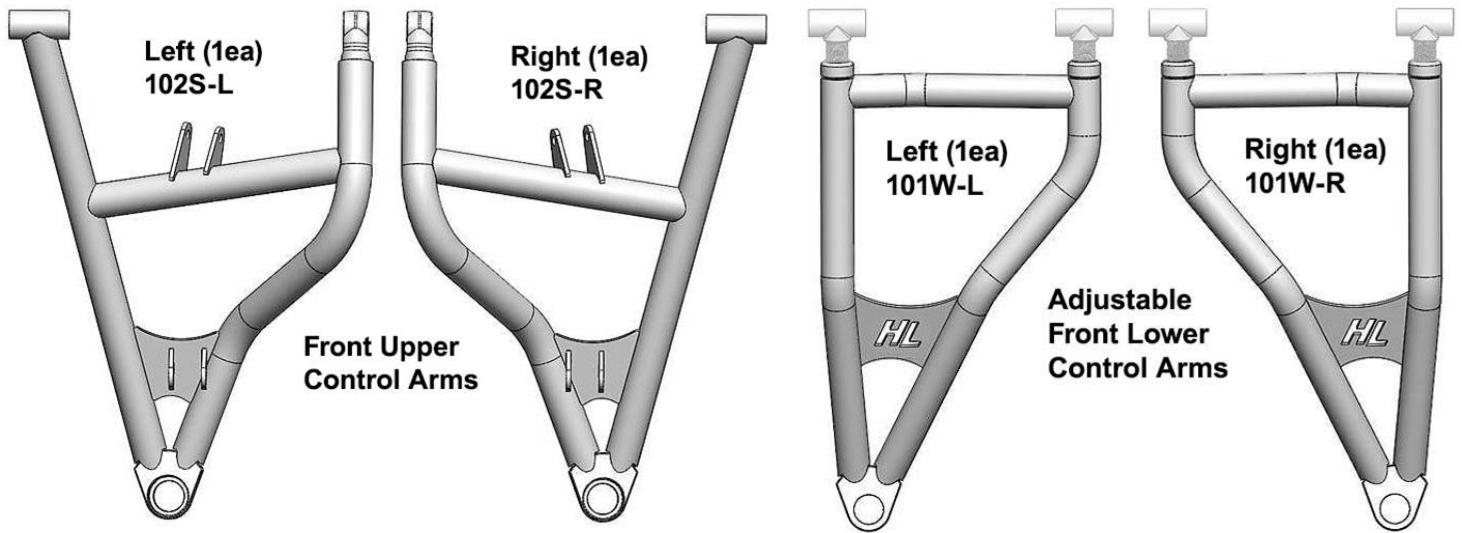

Wide Adjustable
Collar (4ea)
96M



1-14 Jam Nut
(4ea) JN1F

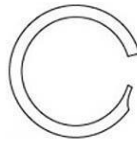

Retaining Ring
(4ea) 68Z



Steering Stop
(2ea) 10U



8" Zip Tie (10ea)
T50RB



11" Zip Tie (2ea)
T11RB

NOTE: These instructions are used in kits that come with or without ball joints. If you have purchased a kit that DOES NOT have ball joints preinstalled and you need replacements, then you will need the following ball joints:

Upper/Lower (4ea) BJP-4

FOR TIPS ON HOW TO PRESS IN BALL JOINTS, SEE THE TIPS SECTION AT THE END OF THESE INSTRUCTIONS

Installation Instructions:

(PASSENGER SIDE)

1. Place jack under center of RUV front end and lift until front wheels clear the ground. Be careful to support the RUV properly so that it is securely supported but so that Control arms and shocks can droop to full extension.
2. Remove front wheels.
3. Disconnect the shock from the upper control arm and secure it out of the way.



4. Disconnect the brake line from the upper control arm. You need to drill out each rivet until they break off.
5. Remove the upper and lower control arms from the RUV. Disconnect the brake caliper, hub assembly, tie rod end, sway bar link, and then the arms from the frame.



6. **The next steps for removing and reusing your factory ball joints only applies if you purchased a kit without ball joints preinstalled. If you purchased a kit with ball joints already installed, then proceed to STEP #10 in the installation instructions.**

7. Remove the ball joints from the stock control arms. You will need to reuse these in the new arms. First remove the snap ring from the ball joint. Then use a vise or a press to remove the ball joint. Be careful not to damage it.



8. Before pressing the ball joints into the new High Lifter control arms, you may need to remove any built-up powder coating that could prevent the ball joint from seating all the way.



9. Install the ball joints into the new control arms.

NOTE: A press or a vise is suggested for removing and replacing the ball joints. If you press in the ball joint crooked, DO NOT TRY TO FORCE IT IN! If you try to force it straight you can “egg” the opening. Press the ball joint out and reinsert it into the opening making sure that it is straight. Once pressed in correctly into the new arm, you need to verify that the clip snaps into place. You should always double check the ball joint snap ring for proper fit. Even if you use snap ring pliers, it may not seat. You can use a flathead screwdriver and a hammer to tap the snap ring to ensure that it is seated into the groove.

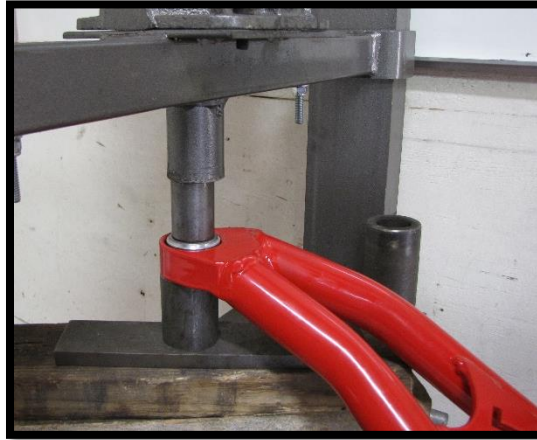

10. Next, remove the bushings and sleeves from the factory arms.

NOTE: Take care when removing the bushing from the collars! There is a stop built into the factory narrow collar that prevents the bushing from pushing out when installed. The bushing will only come out from one side, the side that has the retaining ring in it!!!

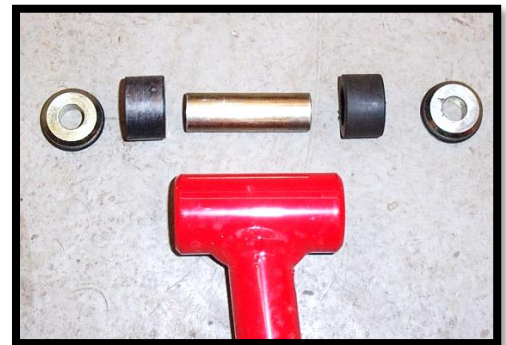
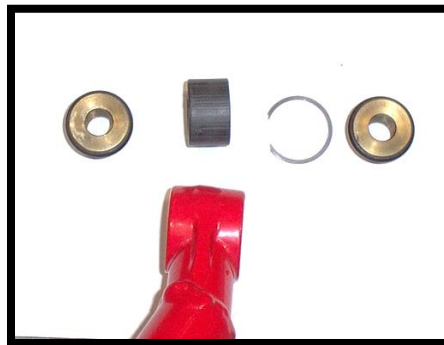

11. In the next steps, reinstall the bushings and sleeves into the new arms and adjustable collars. If you place some grease on them, it makes the installations easier.

NOTE: Leave the adjustable collars installed into the lower arms when installing the bushings. They are already pre-adjusted to factory length.

12. On the new High Lifter control arms, there is not a stop built into the NARROW collars. We include new snap rings for this. Insert a snap ring **104A** into one side, then insert the bushing, tap or press the bushing into place, then insert the second snap ring **104A**. Then insert the sealed pivot caps.

NOTE: Once the bushing is inserted you will need to use a socket to help push it in all the way.

NOTE: You may need to clean out the snap ring groove with a fine point or pick. As the bushing is being inserted material can deposit into the groove, preventing the snap ring from seating.

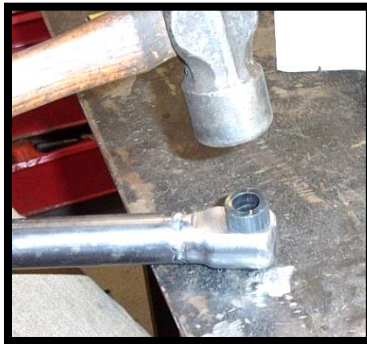

13. For the WIDE collars, follow the directions below.



14. The new lower High Lifter control arms will already come adjusted to factory length. If you need to re-adjust the collars, place the factory arm and new control arm on a flat surface. Measure from eyelet to ball joint on the factory arm, and then adjust the new arms to those estimated lengths.
NOTE: If re-adjusting, leave the jam nuts loose. Do not fasten tight until installed on UTV and after all final adjustments have been made.

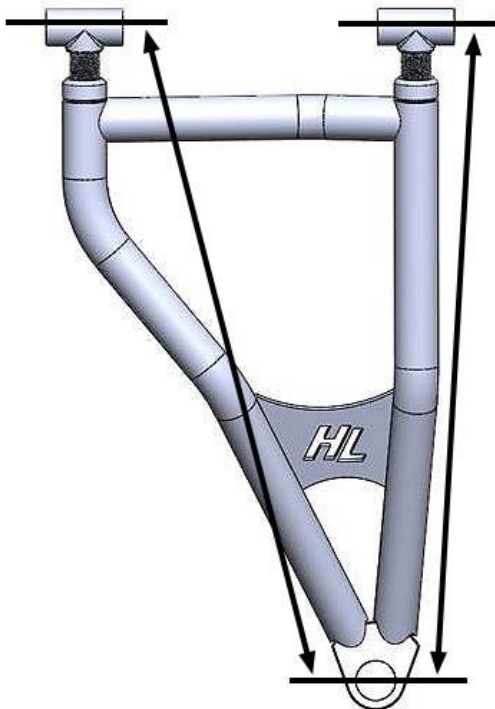

15. Use the factory hardware to connect the new control arms to the frame. Fasten to factory specifications.



16. Reconnect the hub assembly, tie rod end, and sway bar link using factory hardware. Fasten to factory specifications.

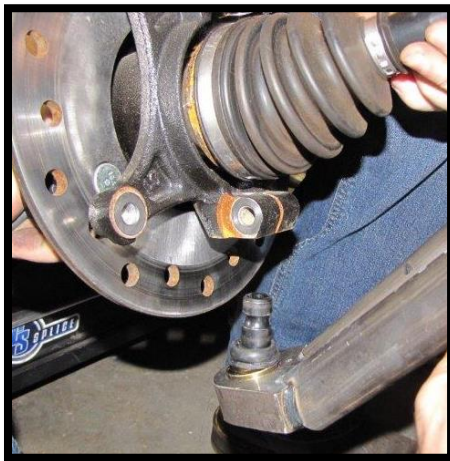

17. If you have not already done so, reconnect the bottom of the shock to the upper arm using the stock hardware. Fasten to factory specifications.



18. Install the brake caliper to the rotor. Fasten to factory specifications.

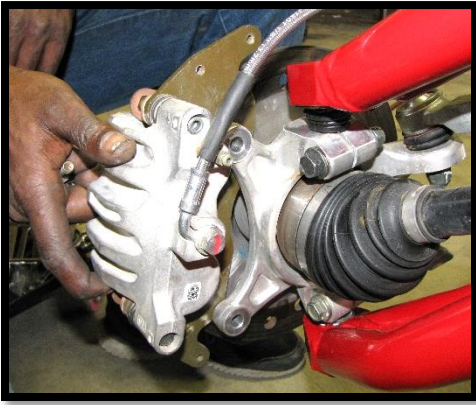

19. Route the brake line up the new upper control arm.

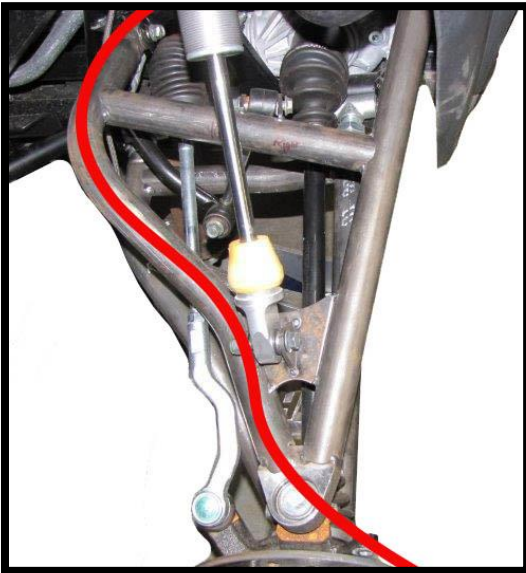

20. Repeat steps for the opposite side. Use the supplied **zip ties** to secure any remaining brake line slack. Make sure there's no binding or interference to the lines.



21. When both sides are complete place wheels back on the UTV and torque lugs to factory specifications.

22. FRONT ALIGNMENT

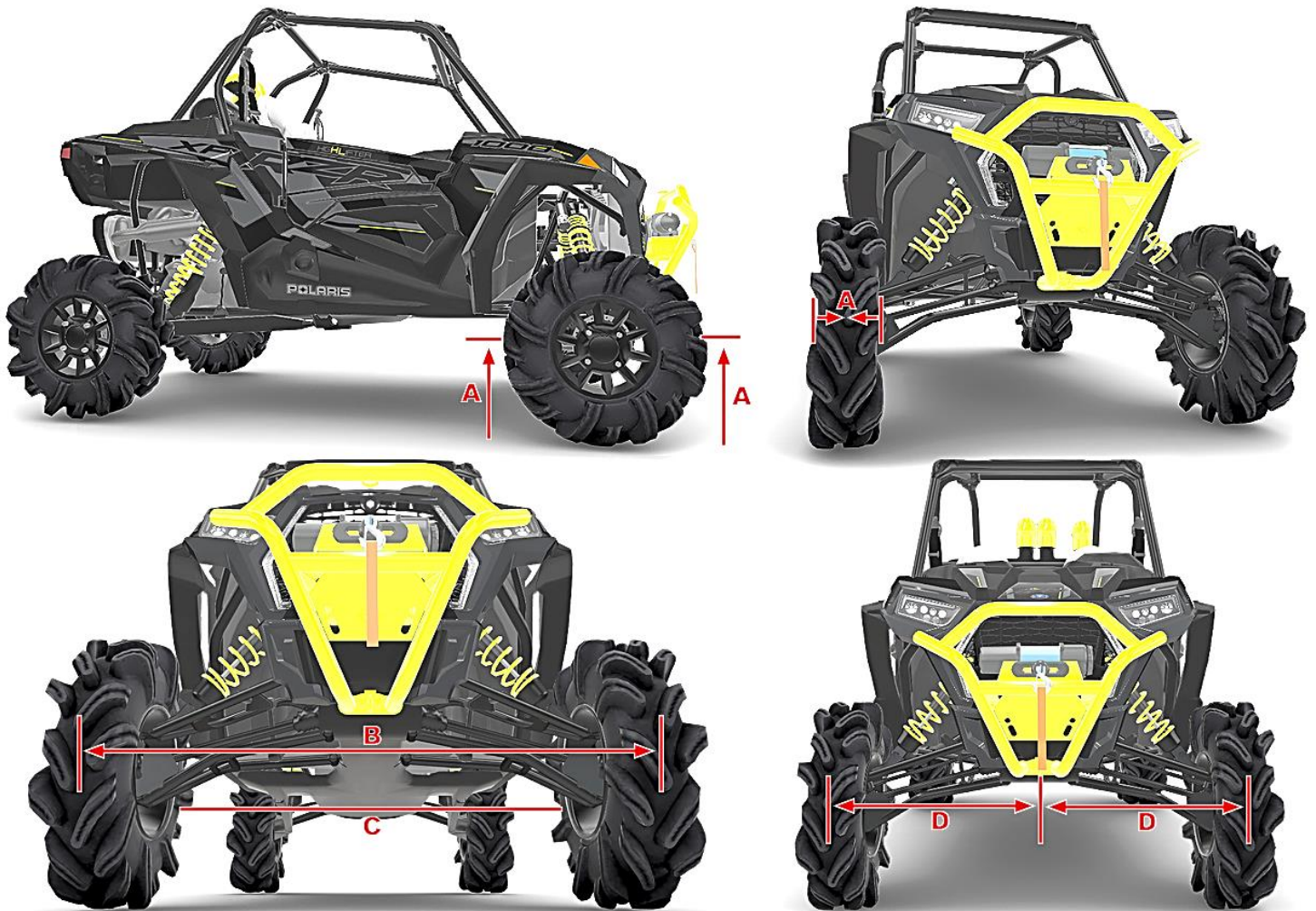

Place the machine on a smooth level surface and set the steering wheel in a 'straight ahead' position. Secure the steering wheel in this position.

- Measure from the floor and place a chalk mark at the center of both front tires. You need mark it at the front and at the rear of each tire, and as close to the hub center line as possible.
NOTE: It is important the height of both marks be equally positioned to get an accurate measurement.
- In the 'Front' of the tires, measure the distance between the center mark of the (LH) tire to the center mark of the (RH) tire. Record the measurement as 'B'.
- In the 'Rear' of the tires, measure the distance between the center mark of the (LH) tire to the center mark of the (RH) tire. Record the measurement as 'C'.

Subtract measurement 'C' from measurement 'B'. The difference between measurement 'B' and 'C' is the vehicle toe alignment. ($B - C = \text{Toe Alignment}$)

The recommended vehicle toe tolerance is 1/8" to 1/4" (3.175-6.35mm) toe out. This means the front measurement (B) is wider than the rear measurement (C).

- If the toe alignment is incorrect, measure the distance between vehicle center and each wheel (use the chalk mark as wheel center). This will tell you which tie rod needs adjusting.

IMPORTANT NOTE: Be sure the steering wheel is straight ahead before determining which tie rod needs adjustment. When tightening the tie rod end jam nuts, the tie rod ends must be held parallel to prevent rod end damage and premature wear. Damage may not be immediately apparent if done incorrectly.

To adjust the toe alignment, hold the tie rod end to keep it from rotating. Loosen the jam nuts at both ends of the tie rod. Shorten or lengthen the tie rod (screw it in or screw it out) until alignment is as required to achieve the proper 'Toe Out' front setting.

After alignment is complete, tighten & torque tie rod end jam nuts to specifications. [12-14 ft lbs]

Thank You
For Choosing
HIGHLIFTER



High Lifter Lifetime Warranty

From the beginning, High Lifter has engineered and manufactured some of the toughest, most durable products on the market. That's why this product comes with a Lifetime Warranty. It's our promise that High Lifter will never let you down.

- The **Lifetime Warranty** covers products sold to the original purchaser only and is not transferable. The term of the warranty is for the lifetime of the vehicle in question.
- Normal wear and tear items and finishes, such as, but not limited to Heim joints, tie rod ends, ball joints, bearings, seals, bushings, bushing sleeves, zinc plating, powder coating, or chipping and discoloration of any finish is not covered.
- High Lifter will ship the replacement product after the returned product has been inspected by High Lifter staff.
- The warranty shall not include claims for damages, installation time or labor charges, economic losses, inconvenience, transportation, towing, down time, direct or indirect or consequential damages or delay resulting from any defect.
- The warranty does not apply to products that have been improperly applied or improperly installed.
- **SPECIAL NOTE:** The warranty for this product will not cover improper installation of ball joints. Any claim relating to a ball joint issue will require inspection before eligibility for warranty can be determined. If the ball joint area shows damage due to improper installation such as, ridges, scarring, impact marks or other signs of improper installation, the warranty will be not be approved.

Making a warranty claim

1. All claims must be accompanied by the part and the original sales receipt or other acceptable proof of purchase from the original owner.
2. All warranties must be accompanied with a Return Merchandise Authorization (RMA) number. (Contact High Lifter at 318-524-2270 or 800-699-0947 for an RMA number)
3. When shipping the damaged product:
 - a. Write the RMA number on the outside of the box.
 - b. Also include the RMA number, proof of purchase and any notes inside the box.
 - c. Please keep your tracking number and shipment information.
4. The customer is responsible for shipping the product to High Lifter--return shipping within the lower 48 states will be paid by High Lifter products. With all warranty claims, only standard shipping services apply.
5. High Lifter will process your order within 24 business hours of receiving the returned item.
6. **Ship to:** High Lifter Products, 780 Professional Drive North, Shreveport, Louisiana 71105

HIGHLIFTER

780 Professional Drive N. Shreveport, LA 71105 Phone (318)-524-2270 Fax (318)-524-2297

Ball Joint Installation Tips and Checks

Review the following steps if you are installing ball joints into your new High Lifter Control Arm Kit

- **SPECIAL NOTE:** The warranty for this product will not cover improper installation of ball joints. Any claim relating to a ball joint issue will require inspection before eligibility for warranty can be determined. If the ball joint area shows damage due to improper installation such as, ridges, scarring, impact marks or other signs of improper installation, the warranty will be not be approved.
1. Verify the ball joint hole is free of paint or materials that could prevent a successful press fit. If there is overspray or paint build up on the top or bottom of the ball joint hole that we missed during manufacturing, use a razor blade, utility knife, or sharp edge to clean the openings on both sides of the ball joint hole. **Do not use a grinder or power tool! This will remove more than paint and can ruin the control arm.**



2. Insert the ball joint into the opening pointing the proper direction and it will seat in the hole to the ring. This helps ensure the ball joint to be pressed in straight. Check to make sure that the rubber boot clears the edge of the hole when you insert the ball joint.



- When pressing in the ball joint, support the ball joint end of the arm in a press with something solid below the arm and will allow the end of the ball joint to pass through completely. Be sure the support arm properly to allow the ball joint to pass through the hole straight and without interference. Again, be sure the boot will clear the fixture you are pressing into and the hole is deep enough for the full length of the ball joint to press into the arm.



- When pressing the ball joint, be sure to fully seat the ball joint so the snap ring can be fully seated. Make sure to clean the snap ring groove of any paint or material that may have become lodged in the groove during the press operation. We recommend you use a pick or fine point to clear the snap ring groove. Use a snap ring tool to secure the snap ring into place.



NOTE: If the ball joint is pressed in too hard it will crack the paint. If this happens then touch up paint can be applied.

- After the snap ring is installed, verify it is fully seated. A screwdriver and a hammer can be used to tap the ring into the groove to fully seat it if necessary. The snap ring can look fully seated but actually still have room to close. If this happens, the ball joint may come out while riding, making this final step extremely important.

